

- Table Top Boundary Microphone
- Low profile, small footprint
- 60Hz to 30kHz
- Very High Intelligibility
- True Semisphere™ Polar Response (near-perfect frequency response at 45° incident to the surface in a hemispherical pattern)
- Unique low frequency filter minimizes noise from table thumping and HVAC
- Reduced pickup of paper shuffling
- Immune to RF interference
- 136dB Max Acoustic Input
- Black, White, Nextel® Dark Black or Stainless Steel Finish

### Earthworks CTB30 Boundary Microphone

The CTB30 is a ground breaking High Definition Boundary Microphone™ that is the ideal choice for high quality teleconferencing applications. It was engineered to deliver crystal clear, highly intelligible reproduction of the human voice at any point around a conference table or other flat surface without the typical problems associated with boundary microphones. Earthworks' trademark clean fast impulse response delivers the subtle details and nuances of the human voice. The CTB30 also incorporates a unique filter that significantly reduces low frequency table thumping and HVAC noise. In addition, the CTB30 delivers an impressive reduction of unwanted sounds from paper and pens. Like all Earthworks microphones, the CTB30 is completely immune to RF interference from mobile phones and other RF sources. The CTB30 is a low profile, pristine sounding microphone solution for permanent or temporary conferencing applications.

### Polar Response

The CTB30 features a True Semisphere™ polar response, meaning voices are picked up equally from anywhere in a 360 degree circle around the table top. It is tuned for flat frequency response from 30 to 60 degrees above the boundary plane. The CTB30 is ideal for complete coverage of any conference or huddle space.

### Installation

The CTB30 has a 10 ft. (3.04m) low profile cable with an XLR-3M attached. For temporary applications, simply set the CTB30 on the table and plug it into a mic input with 24-48V phantom power. For permanent installations, the XLR connector can be removed, allowing the cable to run through a small hole in the surface. Once installed, the connector can be resoldered, if necessary. The CTB30 features two 6-32 screw holes and a keyhole on the bottom of the microphone for secure mounting.

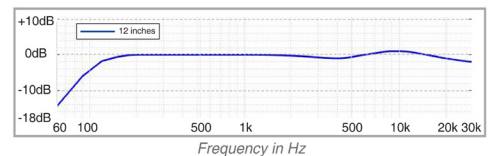
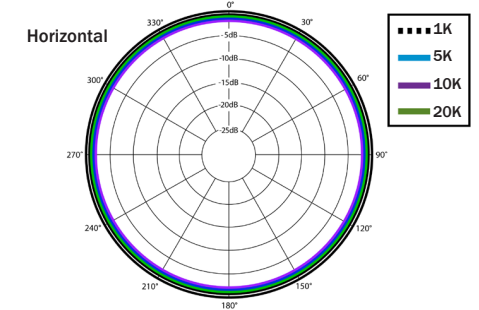
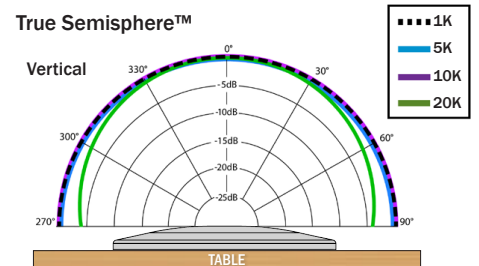

### Architectural & Engineering Specifications - 30kHz Omni

The microphone shall be a back-electret condenser type with a wide-range uniform frequency response of 60Hz to 30kHz -3dB. The microphone shall be of a single capsule, single membrane design with an impulse response rise time no longer than 25 microseconds, and total settling time, including rise time, no longer than 120 microseconds. The microphone shall have polar characteristics uniform in all planes to form an omni semisphere of revolution and shall accept sound pressure levels up to 136dB producing no more than 3%THD. The microphone shall be resistant to RF interference from cell phones and other RF devices and also provide a low frequency filter to reduce table thumping and HVAC noise. The microphone shall measure 4.1 in. (104.1mm) in diameter by 0.45 in. (11.4mm) in height. The microphone shall have a low profile 10 ft. (3.04m) cable terminated with a 3-pin XLR-M connector and shall require 24-48V phantom power. The microphone shall be made of metal with a black, white, stainless steel, or Nextel® Dark Black finish. The Earthworks CTB30 is specified.

Specifications Subject to Change without Notice



### Microphone Placement

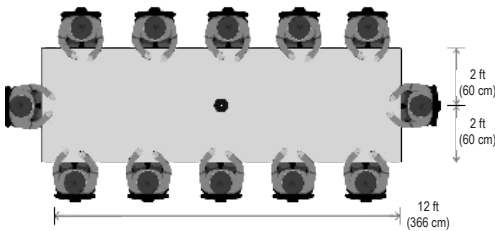

### Microphone Placement

Earthworks CTB30's near-perfect omnidirectional polar pattern provides wide coverage for the user. It typically takes 1 CTB30 to provide even coverage for a 12' conference table.

### Mounting with Cable Through the Table

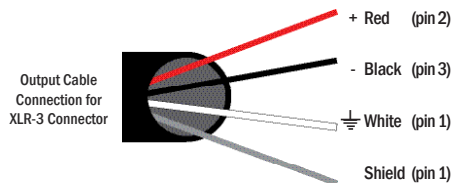
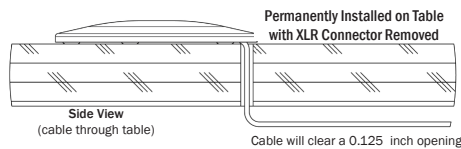
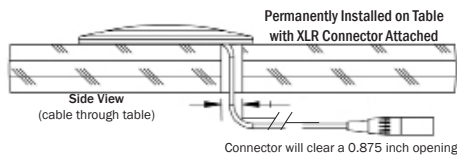

## CTB30

Top View



Bottom View

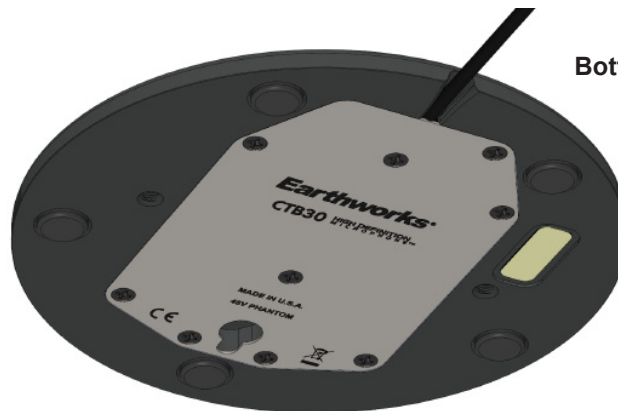

## CTB30 Dimensions

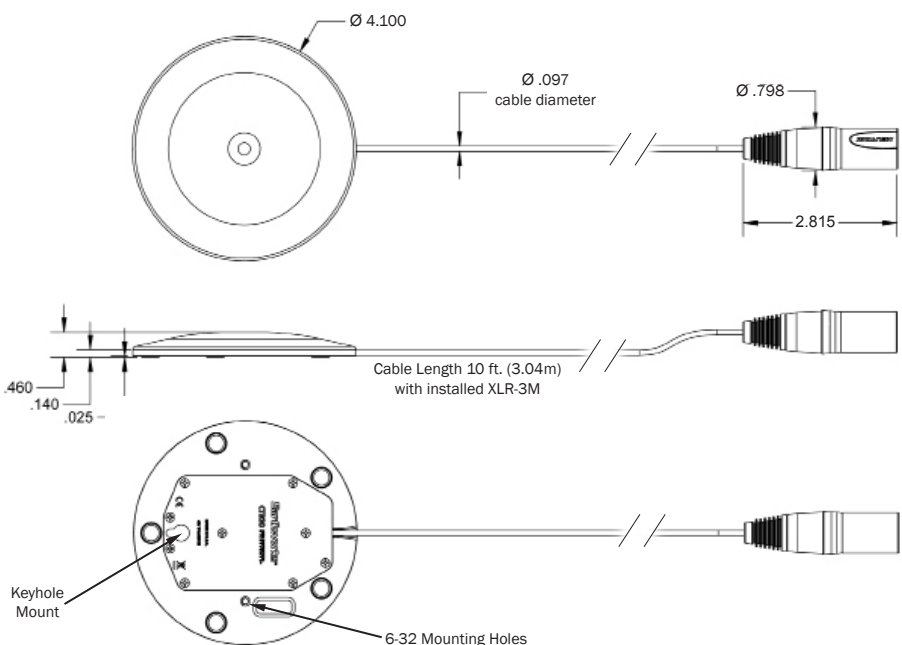

### CTB30 SPECIFICATIONS

Type:	Boundary
Element:	Condenser
Frequency Response:	60Hz to 30kHz -3dB @ 1 ft. (30cm)
Low Frequency Roll-off:	60Hz, 15dB/octave
Polar Pattern:	Omni Hemisphere™
Sensitivity:	60mV/Pa
Impedance:	65 ohms
Power requirements:	24 - 48V Phantom, 10mA
Max Acoustic Input:	136dB @ 1kHz
Dynamic Range:	116dB @1kHz
Signal to Noise Ratio:	74dB @ 1kHz
Output:	XLR-3M. (pin 2+)
Min. Output Load:	1K between pins 2 & 3
Noise:	19dB SPL (A weighted)
Microphone Color:	Black, White, Stainless or Nextel® Dark Black
Dimensions:	4.1 x 4.1 x 0.45 inches (104.1 x 104.1 x 11.4mm)
Cable Length:	10' (3.04m) with installed XLR-3M
Connector Type:	Low profile cable terminated into a 3-pin XLR-M
Weight:	0.36 lbs. (162g)
Specifications subject to change without notice	